

Progress on Light Meson Spectroscopy

Marc Pelizäus

Ruhr-Universität Bochum

(on behalf of the BES III Collaboration)

DIS 2016
April 11-15, 2015
DESY, Hamburg

DFG

BES III

BESIII Physics Program

- Light Hadrons
 - Meson and baryon spectroscopy
 - Search for exotic hadrons, e.g. glueballs, hybrids, tetraquarks
 - Light meson decays ($\eta^{(\prime)}$, ω)
- Charmonium Physics
 - X, Y, and Z states
 - Decays and transitions
- Open Charm Physics
 - D meson decays
 - $D\bar{D}$ mixing
 - CP violation in the charm sector
- And many further topics
 - e.g. tau and two-photon physics

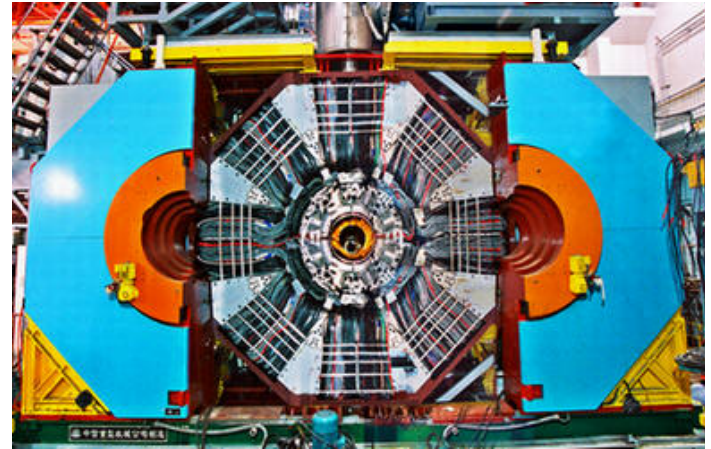

Further BESIII presentations at this workshop

WG 4 Heavy Flavors (Tue.)

Y. Zhang, Charm Physics at BES III

WG 4 Heavy Flavors (Wed.)

A. Guo, XYZ Studies at BES III

BESIII at BEPC II

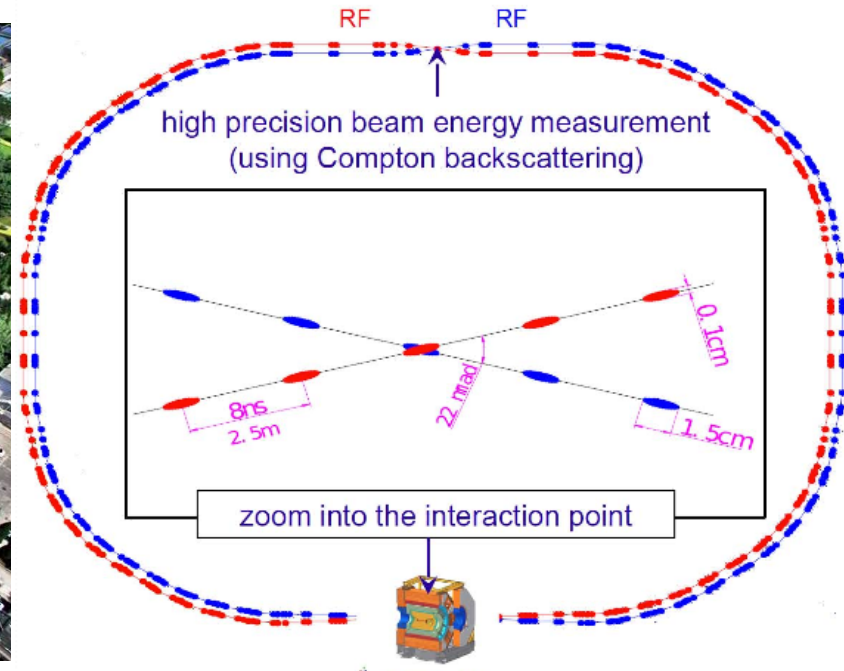

Symmetric electron-positron collider BEPC II

- Energy range: $\sqrt{s} = 2.0\text{-}4.6$ GeV
- Design luminosity: $1 \times 10^{33} \text{ cm}^{-2}\text{s}^{-1}$ (at $\psi(3770)$)
- Energy spread: $\sim 5 \times 10^{-4}$
- Operating since March 2008
- Achieved luminosity: $0.998 \times 10^{33} \text{ cm}^{-2}\text{s}^{-1}$

The BESIII Detector

RPC Muon Detector

8 layers (end caps), 9 layers (barrel)

$$\delta R_{\phi} = 1.4 - 1.7 \text{ mm}$$

Electromagnetic

CsI(Tl) Calorimeter

$$\sigma_E/E < 2.5\%/\sqrt{E}$$

$$\sigma_{z,\phi} = 0.5 - 0.7 \text{ cm}/\sqrt{E}$$

Time of Flight System

$$\sigma_t = 80 \text{ ps} \quad (\text{barrel})$$

$$\sigma_t = 110 \text{ ps} \quad (\text{end caps})$$

Drift Chamber

$$\sigma_{(dE/dx)} = 6\%$$

$$\sigma_{p_t}/p_t = 0.5\%$$

Superconducting Solenoid (1 T)

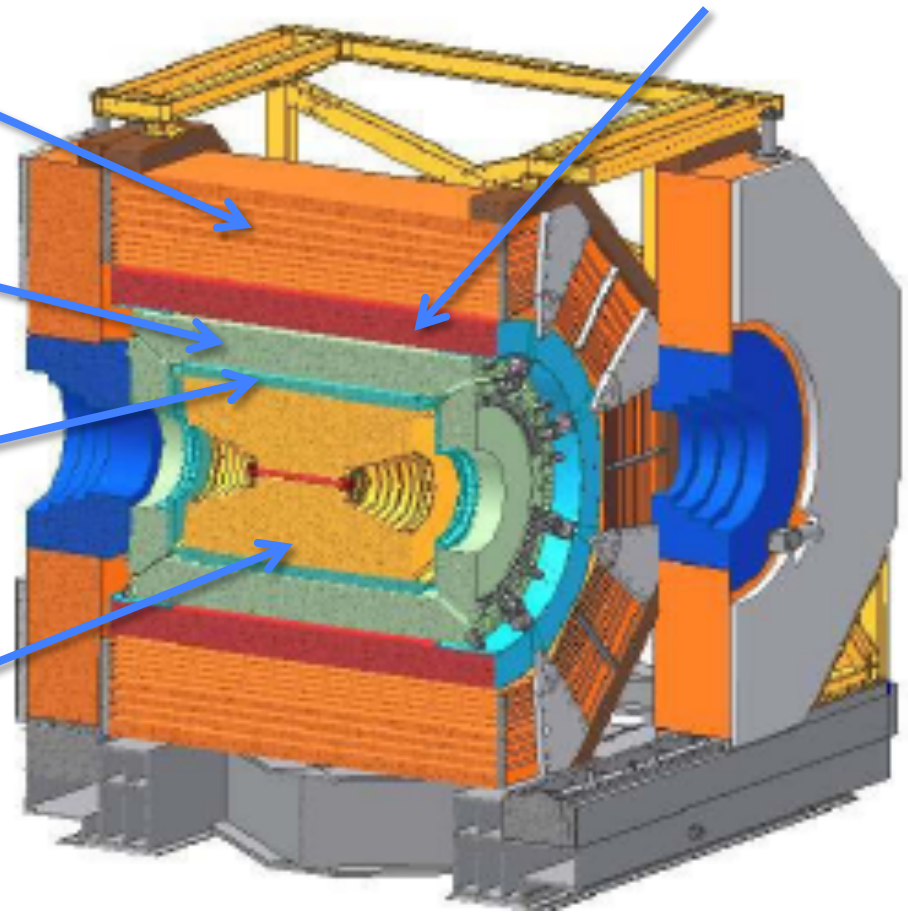

Data Samples

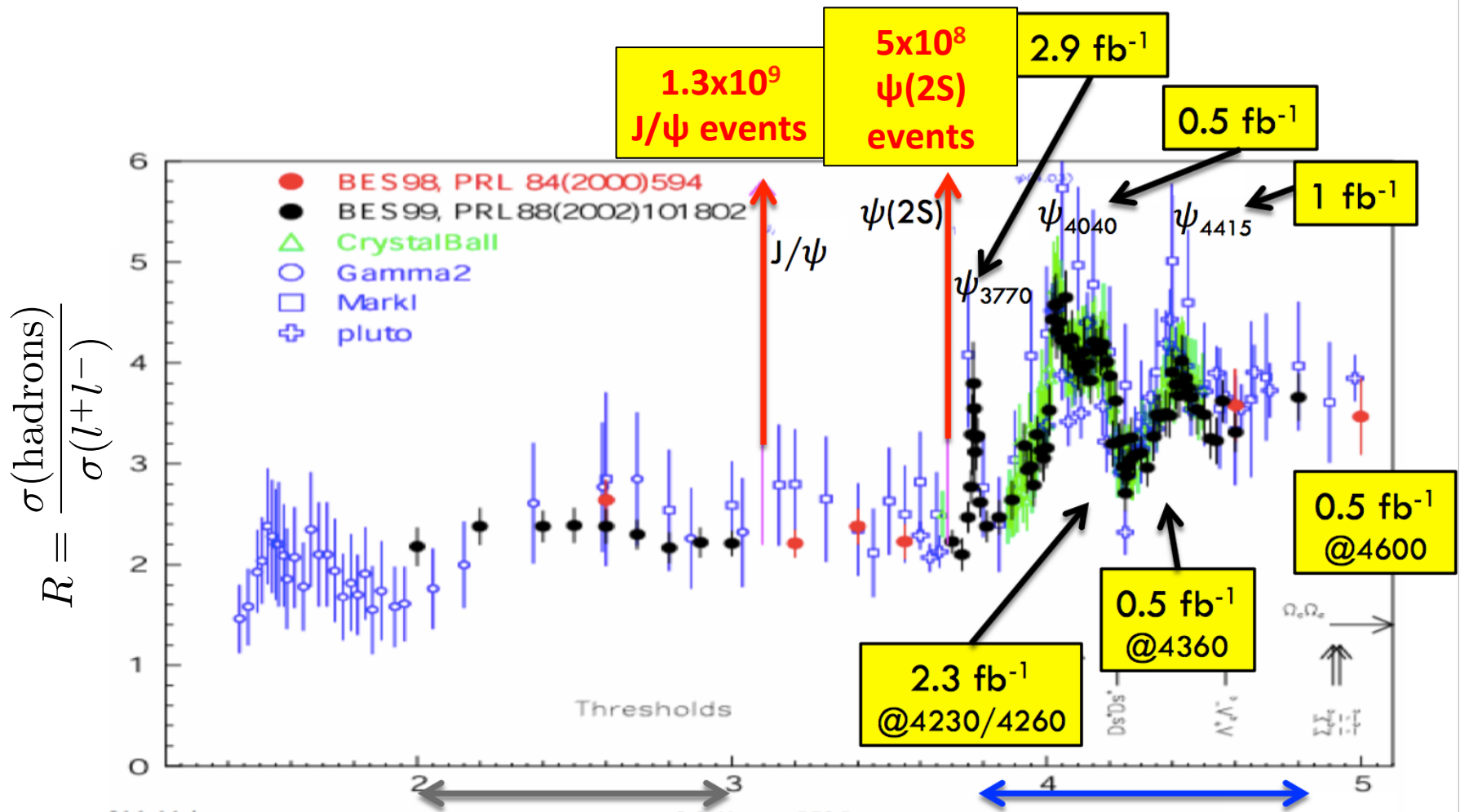



R scan: 2-3 GeV, 19 points, $\sim 0.5 \text{ fb}^{-1}$; 3.85-4.59 GeV, 104 points, $\sim 0.8 \text{ fb}^{-1}$

plus 24/pb at τ mass threshold and
0.5/fb in the region 4100-4400 MeV

Light Meson Spectrum

Color-less $q\bar{q}$ states ($q = u, d, s$)
 Multiplets of $q\bar{q}$ mesons with same J^{PC}

Additional color-less states:

- Glueballs: gg, ggg 
- Hybrids: $q\bar{q}g$ 
- Tetraquarks: $(q\bar{q})(q\bar{q})$ 

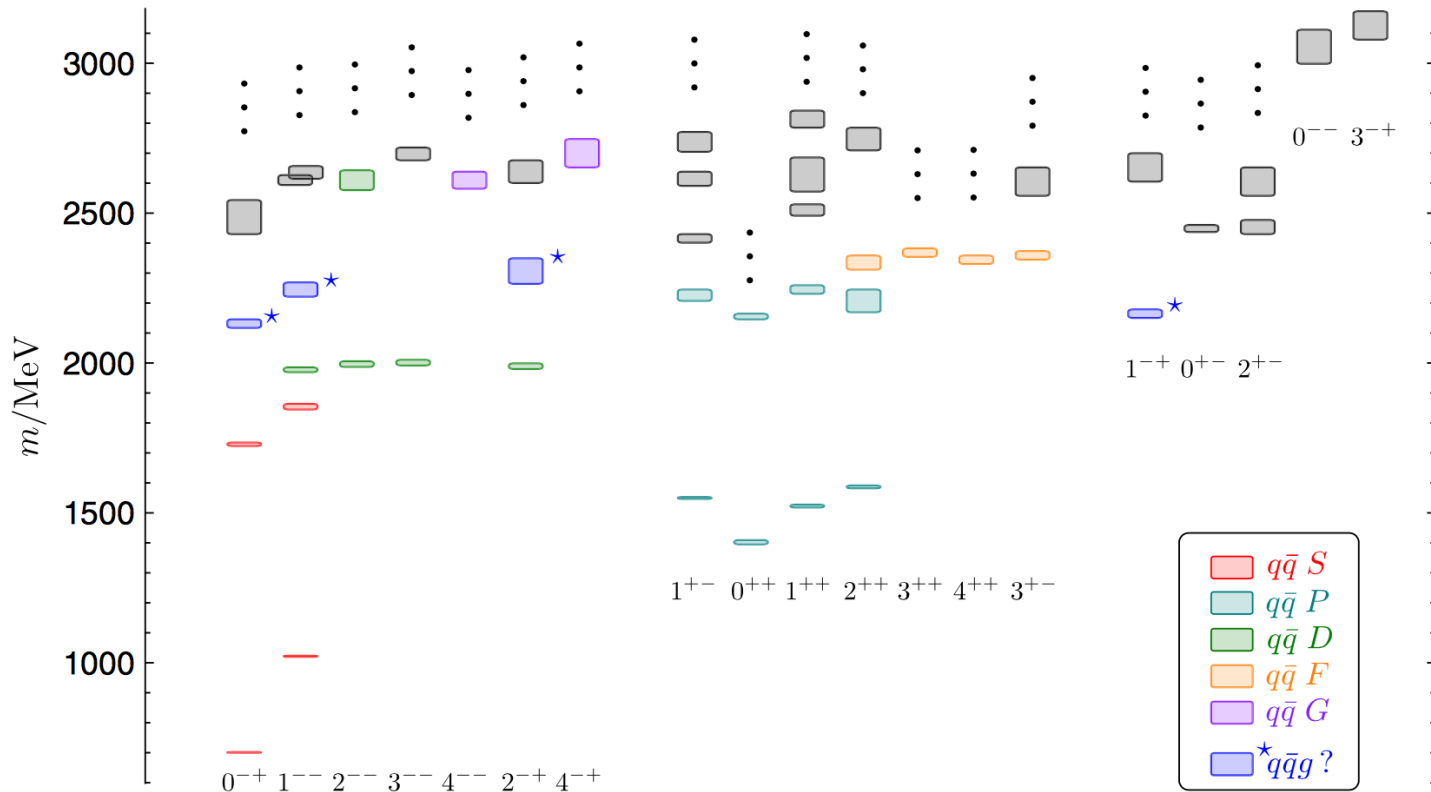

Enhancement at $p\bar{p}$ Threshold

- Enhancement at $p\bar{p}$ threshold observed in $J/\psi \rightarrow \gamma p\bar{p}$ by BESII (2003) and confirmed by CLEOc (2010)
- Enhancement not observed in related channel: $Y(1S) \rightarrow \gamma p\bar{p}$
- Nature yet unclear
 - baryonium, multiquark state, FSI effect ?

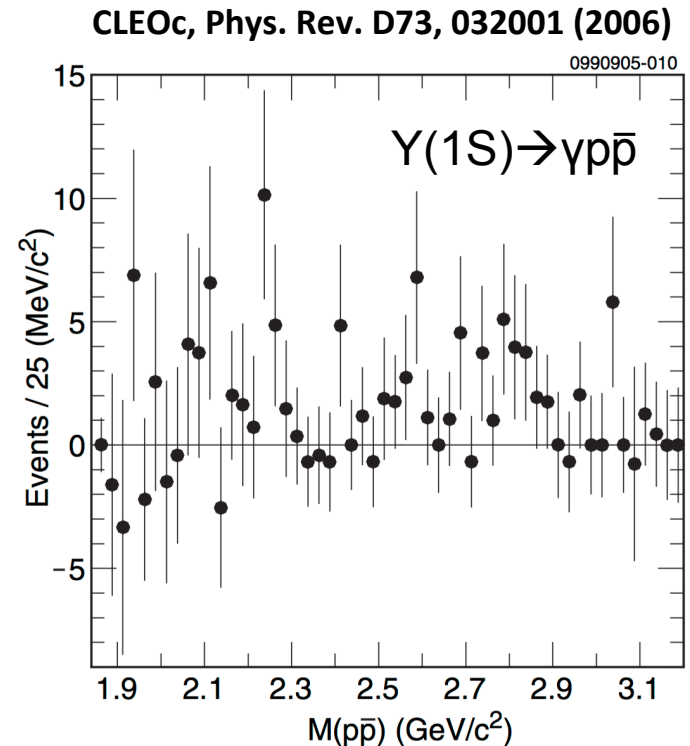
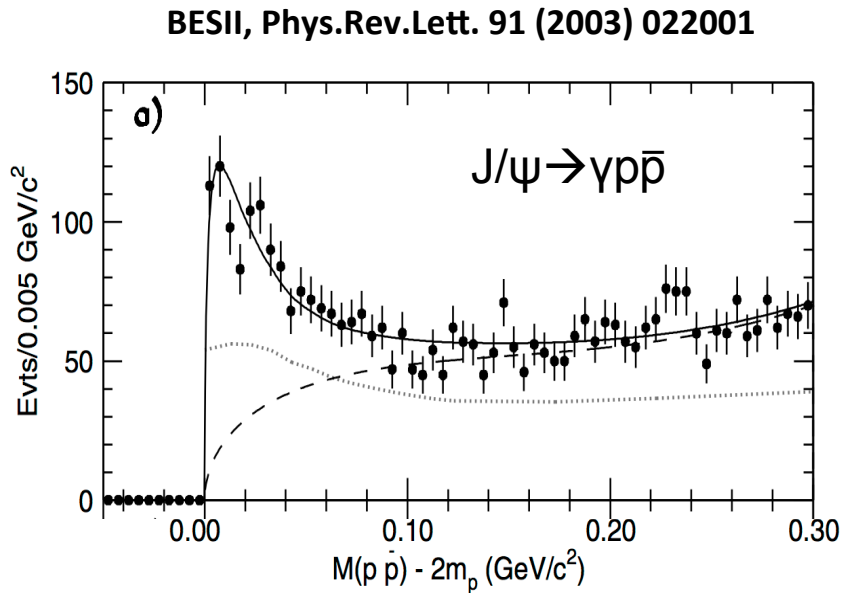

Radiative J/ψ and ψ' Decays

Partial Wave Analysis of $J/\psi \rightarrow \gamma p \bar{p}$ and $\psi' \rightarrow \gamma p \bar{p}$ in the mass region $m_{p\bar{p}} < 2.2 \text{ GeV}/c^2$

$J/\psi \rightarrow \gamma p \bar{p}$: Significant contributions of $X(p\bar{p})$, $f_2(1920)$, $f_0(2100)$, and non-resonant $0^{++} p\bar{p}$ wave

→ Structure at threshold $X(p\bar{p})$: $J^{PC} = 0^{-+}$

Breit-Wigner parameterization:

$$M = 1832^{+19}_{-5}(\text{stat})^{+18}_{-17}(\text{syst}) \pm 19(\text{model}) \text{ MeV}/c^2$$

$$\Gamma = 13 \pm 39(\text{stat})^{+10}_{-13}(\text{syst}) \pm 4(\text{model}) \text{ MeV}/c^2$$

$$\text{BR}_{[J/\psi \rightarrow \gamma X] \times \text{BR}[X \rightarrow p\bar{p}]} = (9.0^{+0.4}_{-1.1}(\text{stat})^{+1.5}_{-5.0}(\text{syst}) \pm 2.3(\text{model})) \times 10^{-5}$$

$\psi' \rightarrow \gamma p \bar{p}$: $X(p\bar{p})$ production is suppressed by a factor of ~ 20 over production in $J/\psi \rightarrow \gamma p \bar{p}$

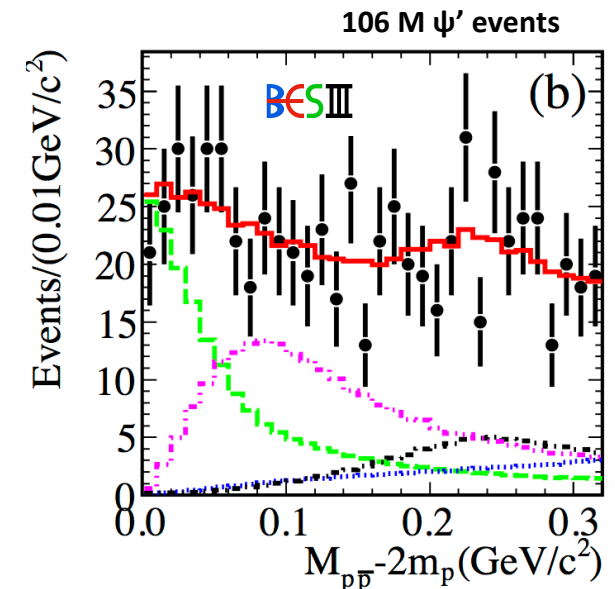
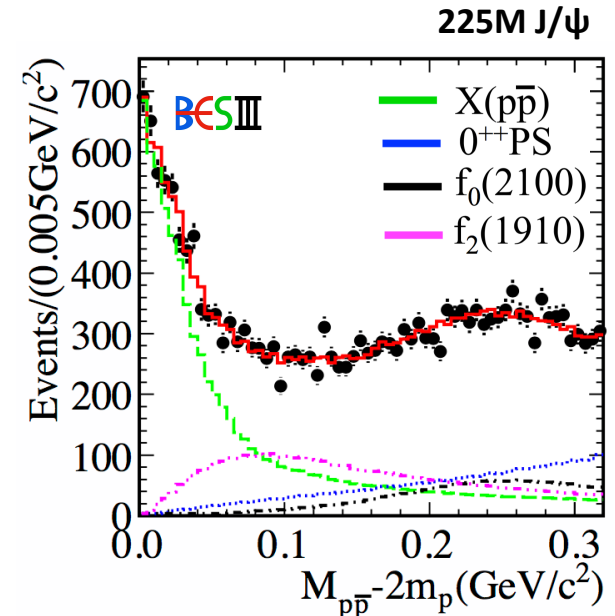

Hadronic J/ψ Decays

Study of $J/\psi \rightarrow \omega p \bar{p}$ and $J/\psi \rightarrow \Phi p \bar{p}$ may shed further light on the nature of $X(p\bar{p})$

$J/\psi \rightarrow \omega p \bar{p}$

$$B(J/\psi \rightarrow \omega X(p\bar{p}) \rightarrow \omega p \bar{p}) < 3.7 \times 10^{-6} \text{ (95\% CL)}$$

>10x suppressed compared to $J/\psi \rightarrow \gamma X(p\bar{p}) \rightarrow \gamma p \bar{p}$

$J/\psi \rightarrow \omega p \bar{p}$

preliminary

$$B(J/\psi \rightarrow \Phi X(p\bar{p}) \rightarrow \Phi p \bar{p}) < 2 \times 10^{-7} \text{ (90\% CL)}$$

>100x suppressed compared to $J/\psi \rightarrow \gamma X(p\bar{p}) \rightarrow \gamma p \bar{p}$

BESIII, Phys. Rev. D87, 112004 (2013)

225M J/ψ

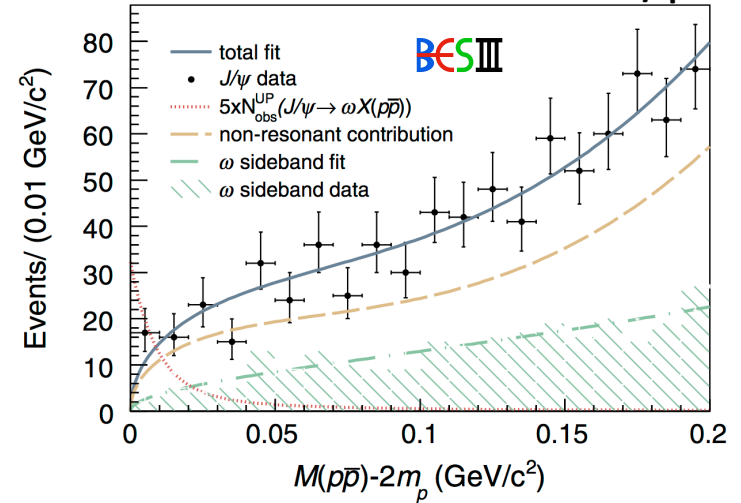

BESIII, arXiv:1512.08197 (2015)

1310M J/ψ

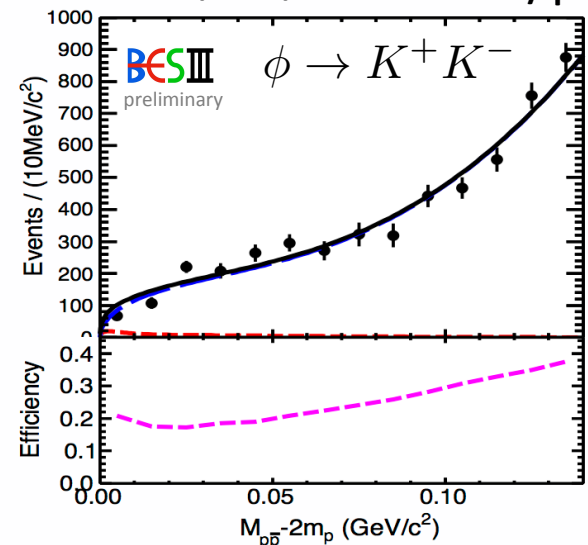
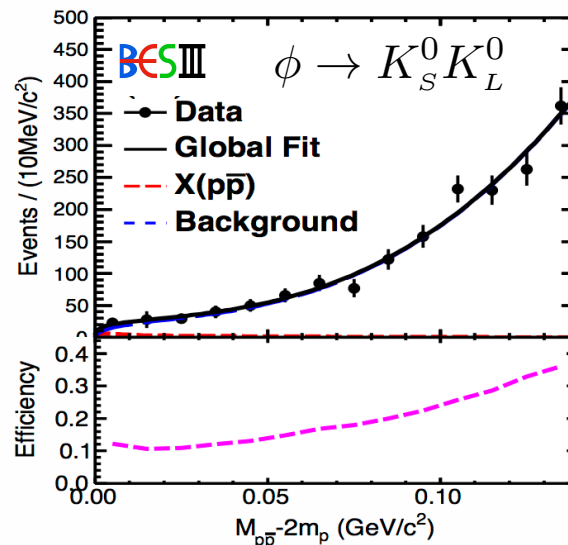

X(1835) in $J/\psi \rightarrow \gamma\pi^+\pi^-\eta'$

BESIII, Phys. Rev. Lett. 106, 072002 (2011)

- X(1835) previously observed at BES and BESII
- Nature unclear, interpretations include glueball, $\bar{p}p$ bound state, excited η meson
- Confirmed at BESIII with two additional structures above 2 GeV/c²

Resonance	$M(\text{MeV}/c^2)$	$\Gamma(\text{MeV}/c^2)$	
$f_1(1510)$	1522.7 ± 5.0	48 ± 11	$>5.7\sigma$
X(1835)	1836.5 ± 3.0	190.1 ± 9.0	$>20\sigma$
X(2120)	2122.4 ± 6.7	83 ± 16	$>7.2\sigma$
X(2370)	2376.3 ± 8.7	83 ± 17	$>6.4\sigma$

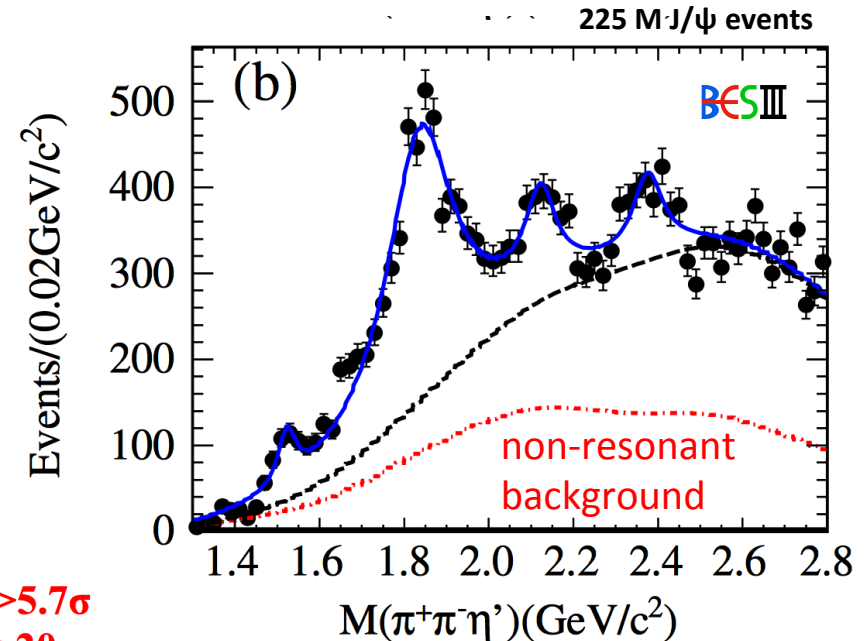

- X(1835) angular distribution consistent with pseudoscalar, but other spin-parity assignments not excluded

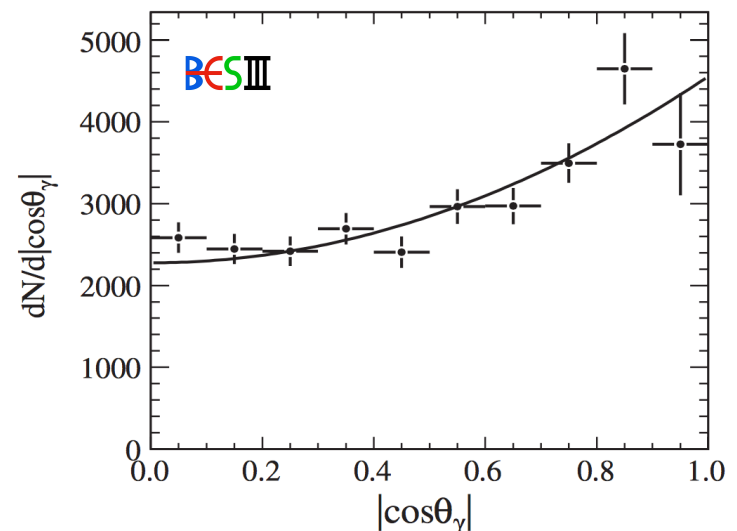

→ Systematic studies of X(1835) ongoing at BESIII (new decay modes, production mechanisms, ...)

X(1835) in $J/\psi \rightarrow \gamma K_S^0 K_S^0 \eta$

BESIII, Phys. Rev. Lett. 115, 091803 (2015)

- Structure in invariant $K_S K_S \eta$ mass at $\sim 1.85 \text{ GeV}/c^2$
- Strong correlation with enhancement at $K_S K_S$ mass threshold (interpreted as $f_0(980)$)
- Structure in $K_S K_S \eta$ is enhanced for $m(K_S K_S) < 1.1 \text{ GeV}/c^2$

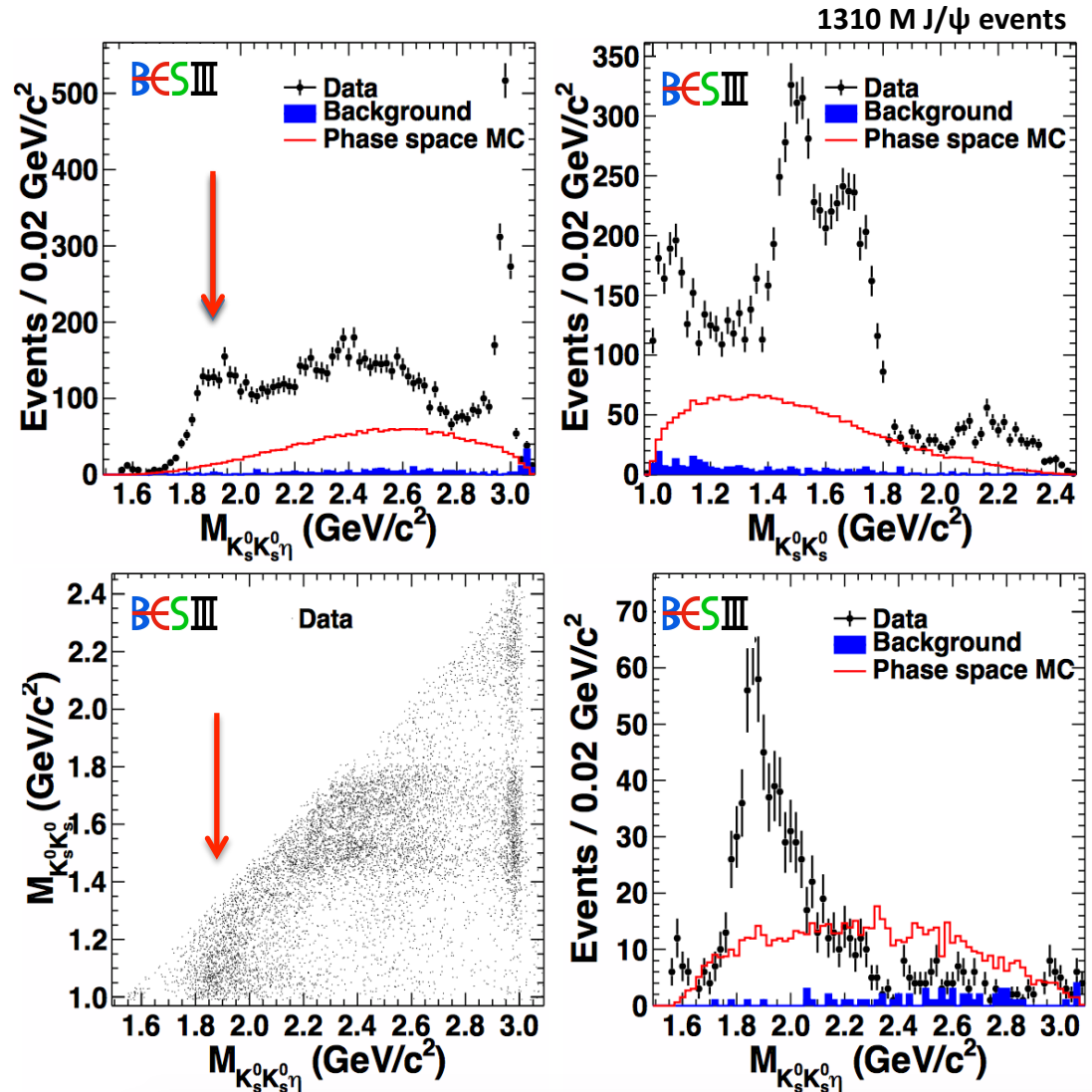

X(1835) in $J/\psi \rightarrow \gamma K_S^0 K_S^0 \eta$

BESIII, Phys. Rev. Lett. 115, 091803 (2015)

- Partial wave analysis for $m(K_S K_S) < 1.1 \text{ GeV}/c^2$ and $m(K_S K_S \eta) < 2.8 \text{ GeV}/c^2$
- Two resonant pseudoscalar components (Breit-Wigner parameterization) required in best fit hypothesis

$$X(1835) \rightarrow f_0(980)\eta \quad (>12.9\sigma)$$

$$m = 1844 \pm 19_{-25}^{+16} \text{ MeV}/c^2$$

$$\Gamma = 192_{-17-43}^{+20+62} \text{ MeV}$$

$$X(1560) \rightarrow f_0(980)\eta \quad (>8.9\sigma)$$

$$m = 1565 \pm 8_{-63}^{+0} \text{ MeV}/c^2$$

$$\Gamma = 45_{-13-28}^{+14+21} \text{ MeV}$$

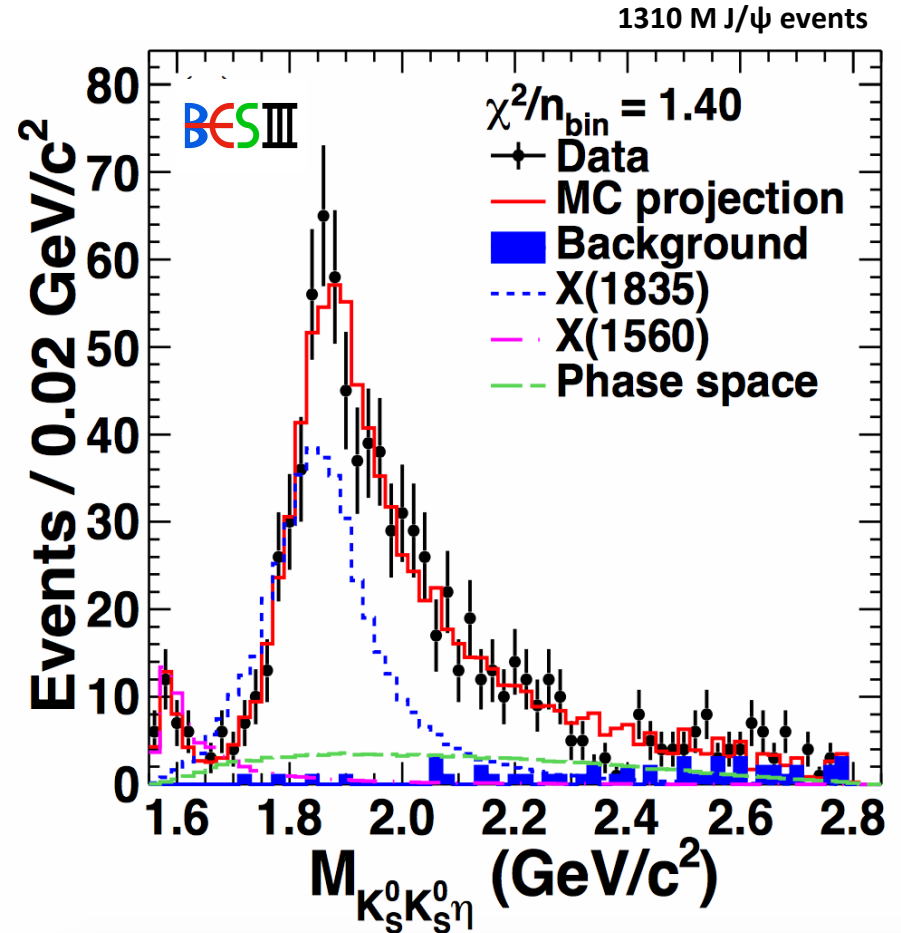

Values consistent with those of $\eta(1405)$ / $\eta(1475)$ at $\sim 2\sigma$
→ needs further investigation

New: Connection of $X(p\bar{p})$ and $X(1835)$

preliminary

- If $X(1835)$ couples to $p\bar{p}$ the lineshape would be affected at the $p\bar{p}$ threshold
- Update of $J/\psi \rightarrow \gamma \pi^+ \pi^- \eta'$ analysis with 1.09×10^9 J/ψ events
 - Using $\eta' \rightarrow \eta \pi^+ \pi^-$ and $\eta \rightarrow \gamma \pi^+ \pi^-$
 - $X(1835)$, $X(2120)$, $X(2370)$ and η_c signals; structure at ~ 2600 MeV/c^2

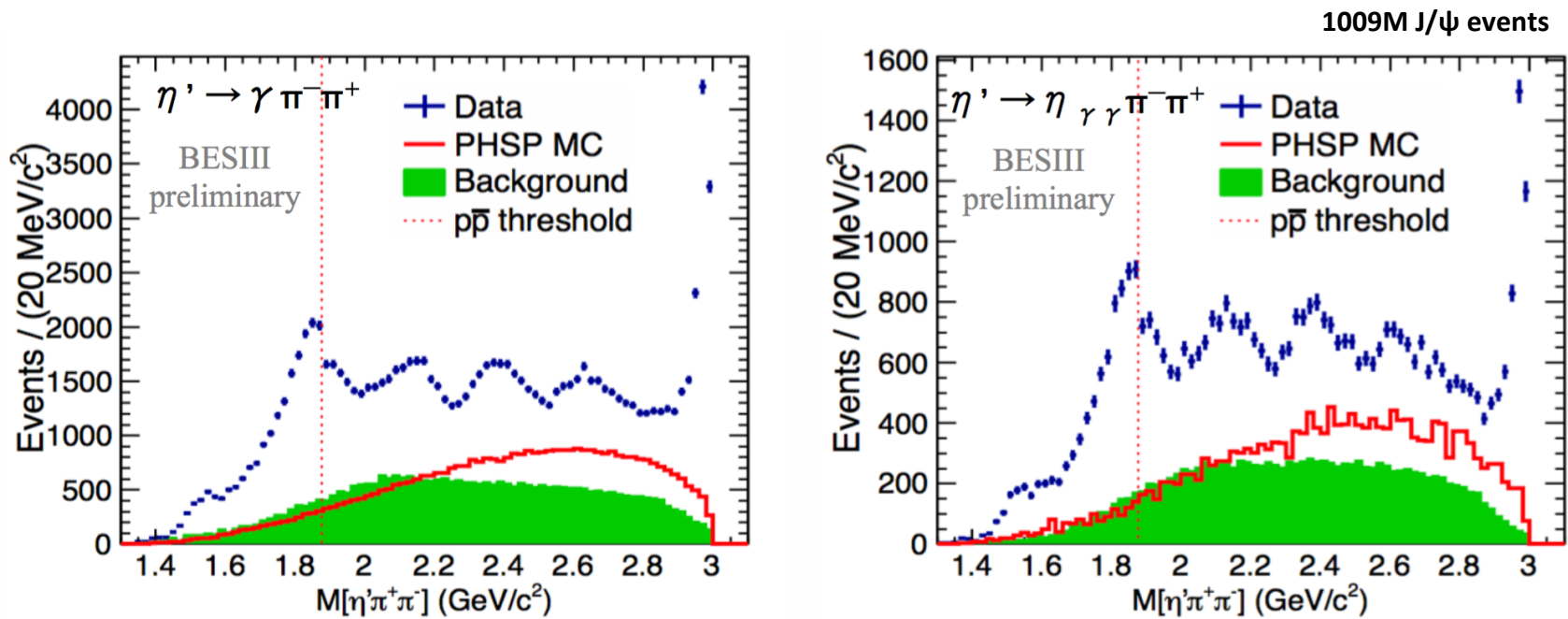

Drop of the $X(1835)$ lineshape at the $p\bar{p}$ threshold !

New: Connection of X(p \bar{p}) and X(1835)

preliminary

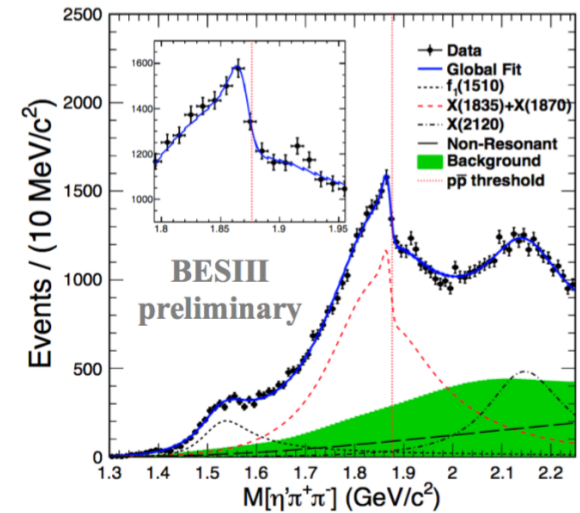
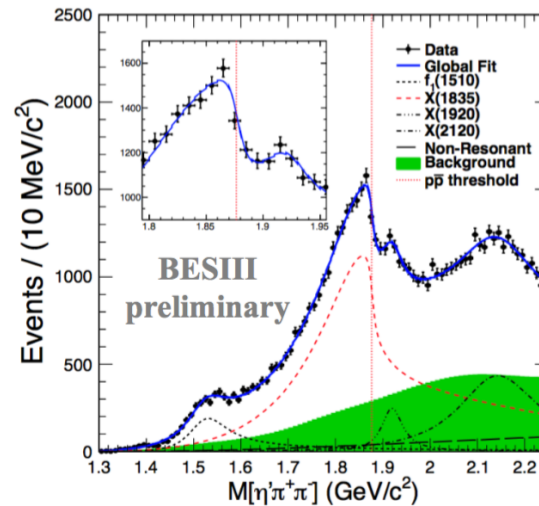
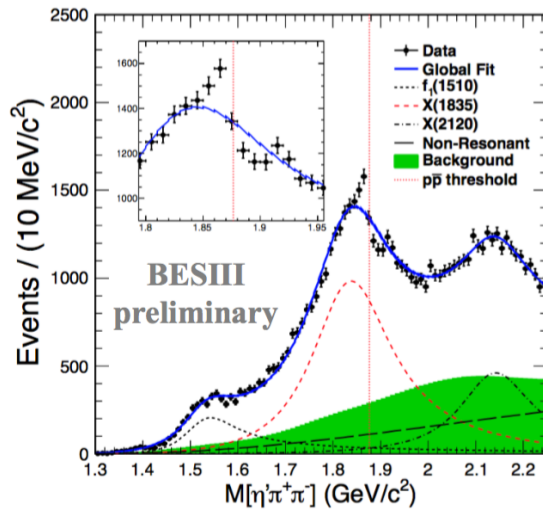

Parameterization with single Breit-Wigner fails to describe the data

Model 1:
Flatte lineshape with strong coupling to $p\bar{p}$ and one additional, narrow Breit-Wigner at $\sim 1920 \text{ MeV}/c^2$

Model 2:
Coherent sum of X(1835) Breit-Wigner and one additional, narrow Breit-Wigner at $\sim 1870 \text{ MeV}/c^2$

Model 1 and 2 yield almost equal fit quality
Both fits suggest two resonances:

- one broad resonance below threshold
- one narrow state very close to $p\bar{p}$ threshold

Further Observations At $p\bar{p}$ Threshold

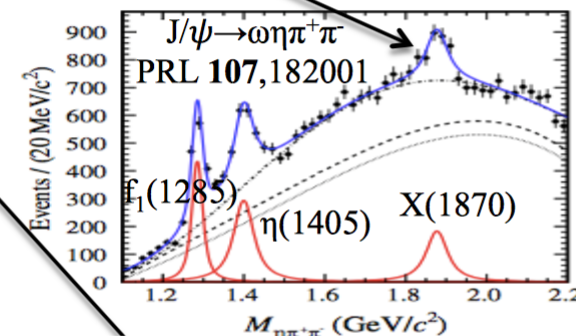
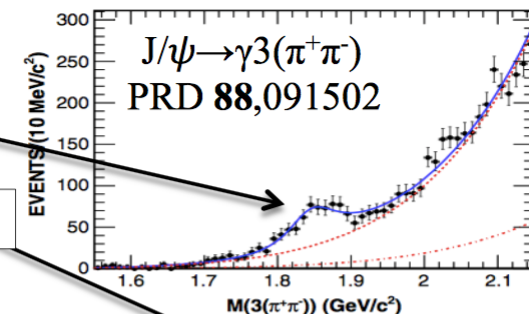
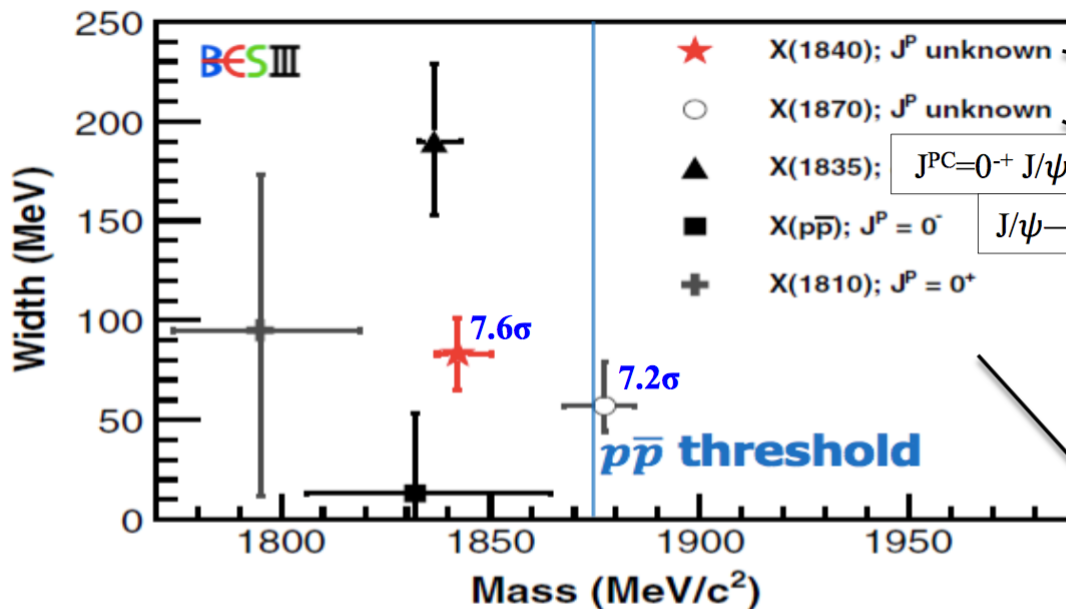

$J/\psi \rightarrow \gamma\omega\phi$
PRD 87,032008
>30 σ

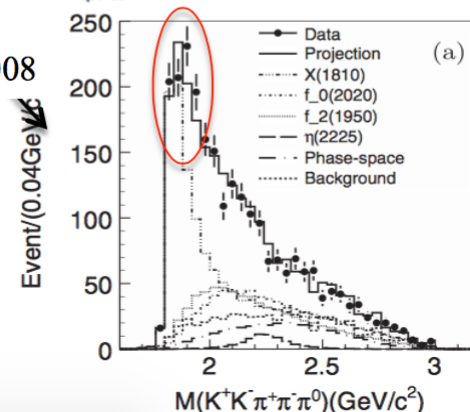

- Same origin?
- Further investigations required to clarify
 - J^{PC} not determined for all structures
 - Coupled channel analysis including various final states and production mechanisms

Model Independent PWA of $J/\psi \rightarrow \gamma \pi^0 \pi^0$

- Radiative J/ψ decays into two pseudoscalar mesons
 - Search for scalar and tensor glueballs (predicted at ~ 1.5 to ~ 2 GeV/c^2)
- $\pi^0 \pi^0$ system: only significant 0^{++} and 2^{++} contributions
 - Many broad and overlapping resonances, many open channels
 - complex structure, parameterization challenging
 - Model Independent Partial Wave Analysis

>440k reconstructed events
at a background level of 1.8%

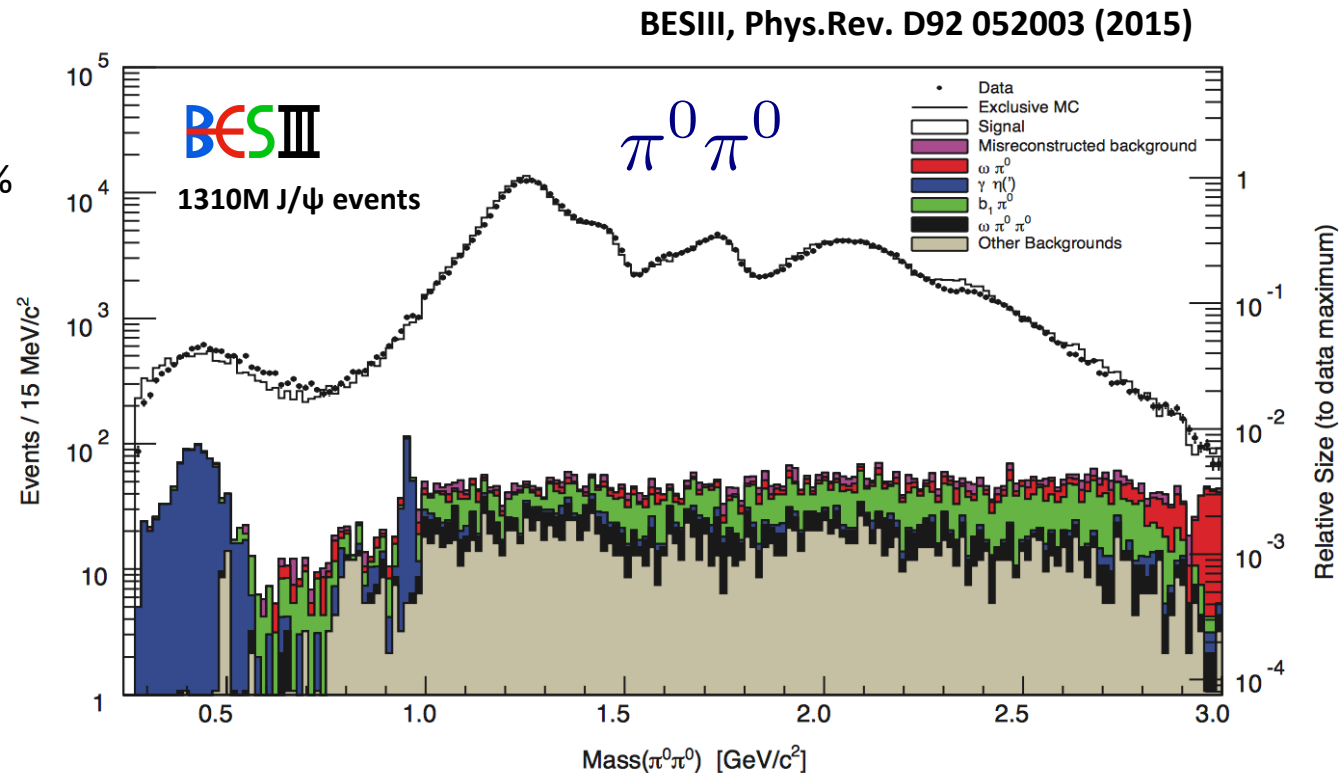

Model Independent PWA of $J/\psi \rightarrow \gamma \pi^0 \pi^0$

Extracted Intensity

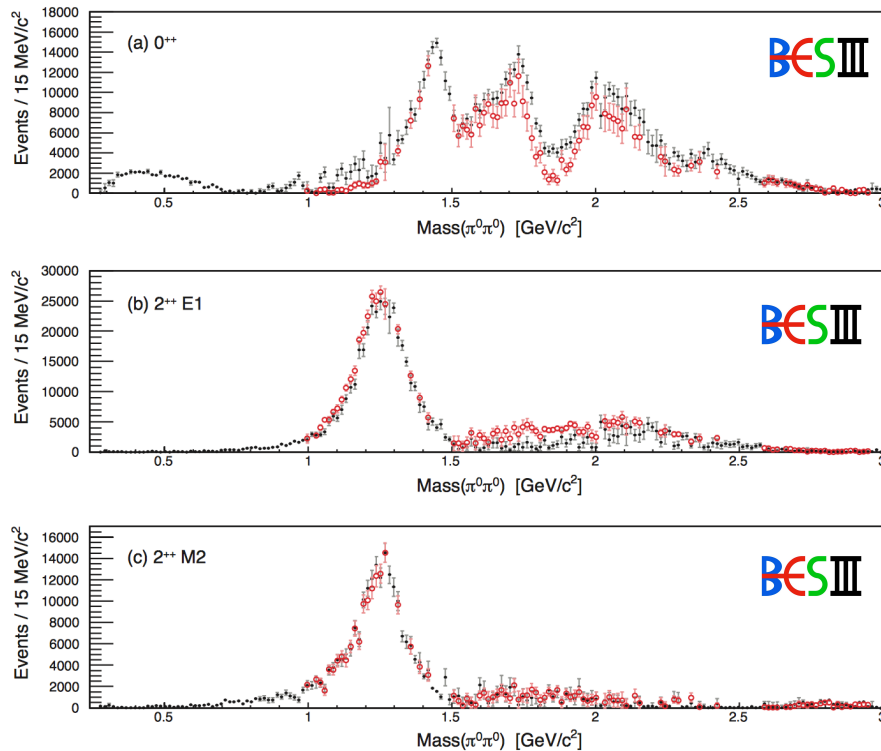

Relative Phase wrt/ 2⁺⁺ E1 amplitude

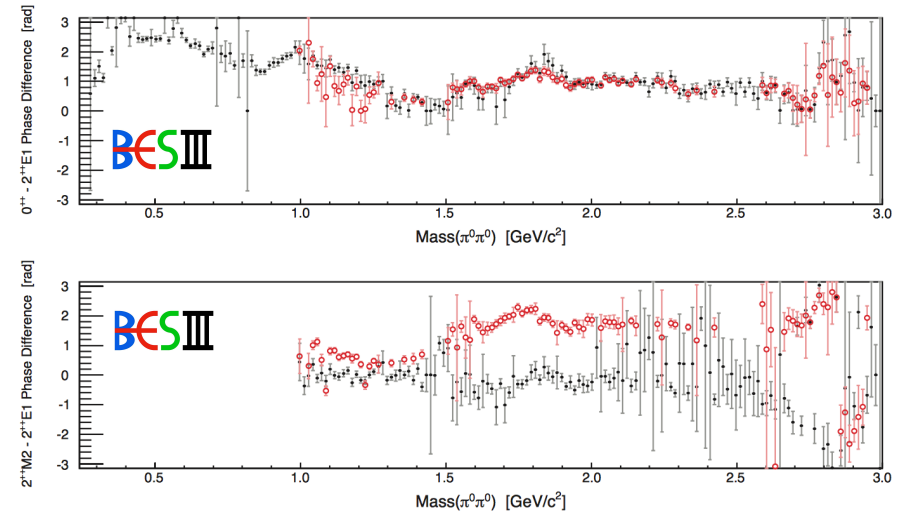

nominal solution
ambiguous solution

Ambiguities may be resolved in a model-dependent fit enforcing continuity between neighboring mass intervals

Model independent approach is under investigation for other systems (e.g. $\eta\eta$, KK)
→ improve our understanding of the nature of the observed resonances

Partial Wave Analysis of $\chi_{c1} \rightarrow \eta\pi^+\pi^-$

- Spin-exotic 1^{-+} states
 - $\pi_1(1400) \rightarrow \eta\pi, \rho\pi$ (?) [GAMS, KEK, Crystal Barrel, E852]
 - $\pi_1(1600) \rightarrow f_1\eta', \eta'\pi, b_1\pi$ [VES, E852, COMPASS, CLEOc]
 - recently seen in $\chi_{c1} \rightarrow \eta'\pi^+\pi^-$ by CLEOc
 - not observed in $\eta\pi$ decays
- $a_0(980)$
 - discovered four decades ago, nature not resolved
 - $a_0(980) \rightarrow \eta'\pi$ only observed recently by CLEOc
 - $a_0(980) \rightarrow \eta\pi$ coupling poorly known
 - various experiments: $0.15 \pm 0.2 < g_{\eta\pi}^2 [\text{GeV}^2] < 0.36 \pm 0.04$
- BESIII: $\chi_{c1} \rightarrow \eta\pi^+\pi^-$
 - about 40M χ_{c1} produced from $\psi' \rightarrow \gamma\chi_{c1}$
 - clean environment to search for 1^{-+} states
 - determine coupling $g_{\eta'\pi}^2$ from $a_0(980)$ lineshape

Partial Wave Analysis of $\chi_{c1} \rightarrow \eta\pi^+\pi^-$

preliminary

~35k reconstructed χ_{c1}
purity: ~99%

New feature compared to CLEO-c
results: consistent with $a_2(1700)$

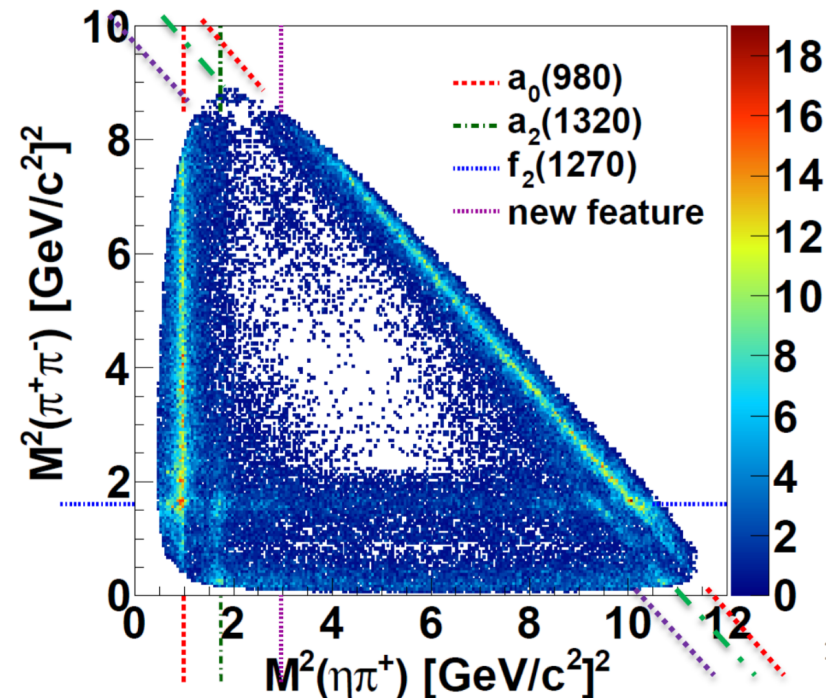
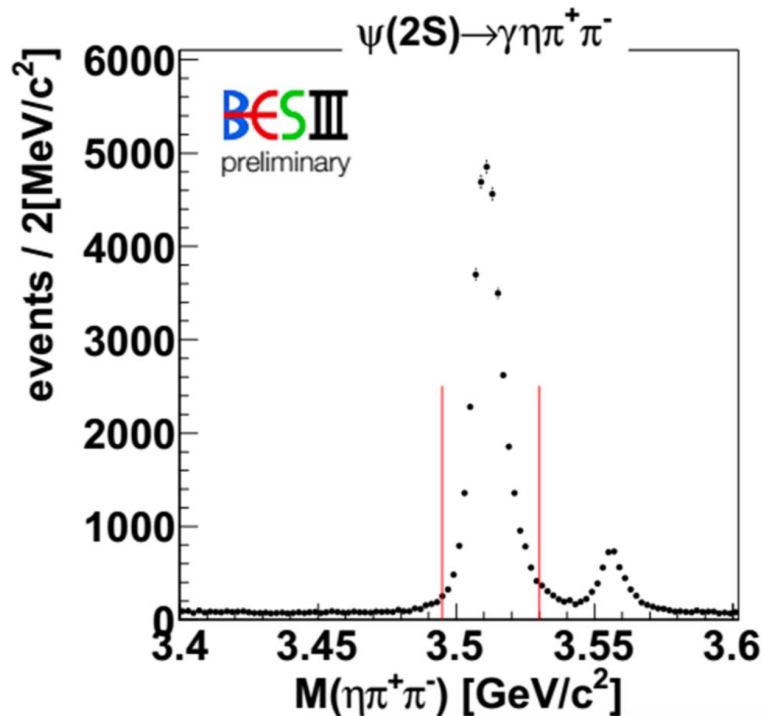

Partial Wave Analysis of $\chi_{c1} \rightarrow \eta \pi^+ \pi^-$

preliminary

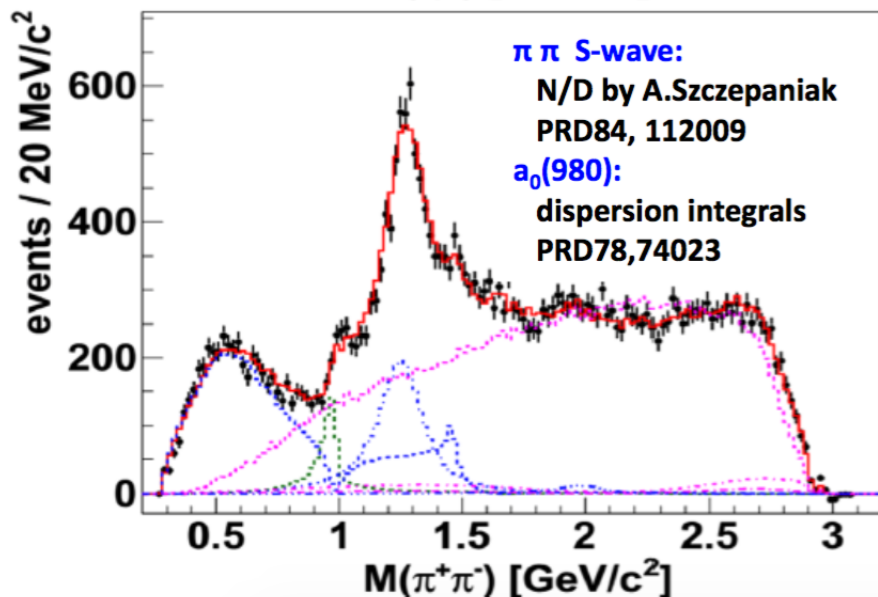
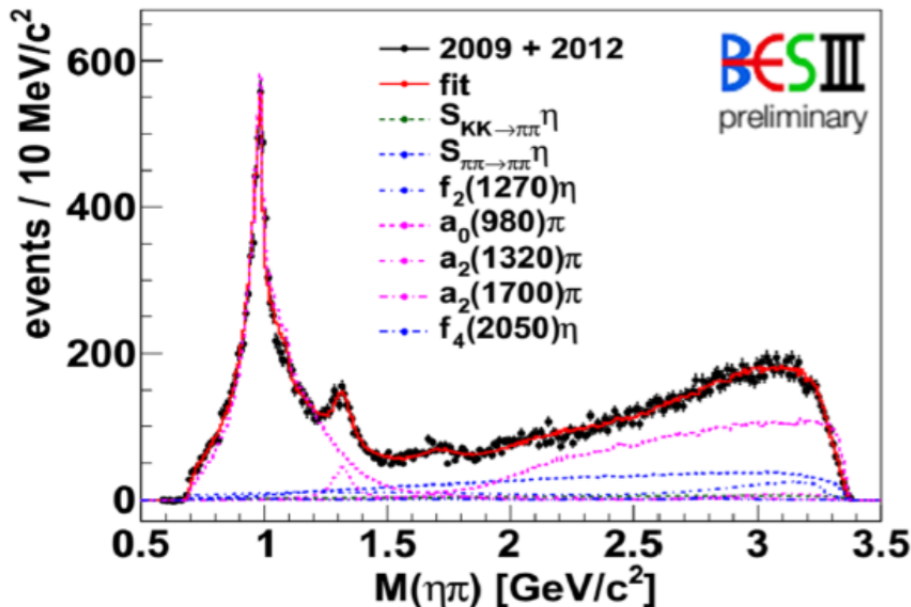

Clear evidence for $a_2(1700)$

Upper limits on $B(\chi_{c1} \rightarrow \pi_1 \pi \rightarrow \eta \pi^+ \pi^-)$
for 1^+ $\eta \pi$ wave

$\pi_1(1400)$: < 0.048 (90% CL)

$\pi_1(1600)$: < 0.016 (90% CL)

$\pi_1(2015)$: < 0.008 (90% CL)

Measurement of $a_0(980)$ couplings

Experiment	BESIII	CLEO-c[1]
m_0 [GeV/c^2]	$995.5 \pm 2.4 \pm 6.5$	998 ± 16
$g_{\eta\pi}^2$ [GeV/c^2]	$0.368 \pm 0.003 \pm 0.013$	0.36 ± 0.04
$g_{KK}^2 / g_{\eta\pi}^2$	$0.93 \pm 0.03 \pm 0.09$	0.87 ± 0.15
$g_{\eta'\pi}^2 / g_{\eta\pi}^2$	$0.49 \pm 0.05 \pm 0.10$	0.00 ± 0.17

Significantly different from 0

Conclusions and Outlook

- BESIII is successfully operating since 2008
 - World's largest data sample at the J/ψ and ψ' resonance recorded
 - Clean and rich source for light hadron production
- Systematic studies to understand $X(1835)$ and other structures observed near $p\bar{p}$ threshold
 - $X(1835)$ nature unclear: $p\bar{p}$ bound state, glueball, excited η meson?
- Sophisticated Partial Wave Analyses well underway
 - $J/\psi \rightarrow \gamma\pi^0\pi^0$: model independent approach \rightarrow rich structure in $\pi\pi$
 - future: couple with other channels to reveal nature of observed resonances
 - $\chi_{c1} \rightarrow \eta\pi^+\pi^-$: further knowledge on exotic 1^{-+} states, $a_0(980)$ and $a_2(1700)$

Exciting times in light hadron spectroscopy with many important results and still more to come!

The BES III Collaboration

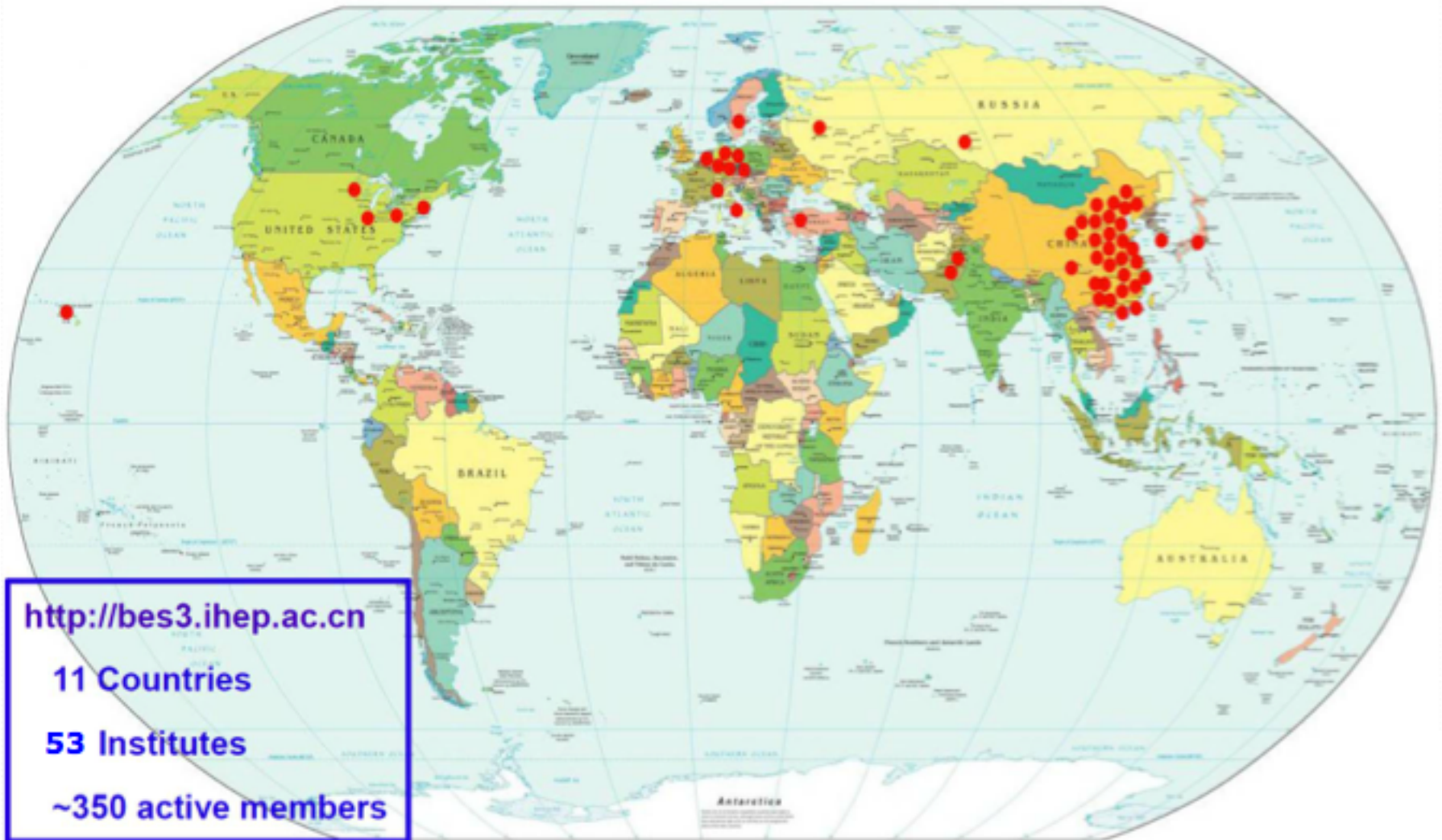

<http://bes3.ihep.ac.cn>

11 Countries

53 Institutes

~350 active members